

An Amazing Bookcase with Tons of Style!

DIY Plans to Build a Circle Bookcase

How can you not fall in love with this bookcase? I love the circle detail on the sides and trust me, they are very easy to create! The DIY plans to build a Circle Bookcase feature three circles on the sides with a straight board in between, three shelves and a roomy top. The half-circles pieces can be stacked and cut as multiples especially if you own a bandsaw. If not, the pieces can be stacked in two and cut with a jigsaw. This is a project that can definitely be completed in a weekend.

build a
circle
bookcase



DESIGNS BY
STUDIO C

Materials:

- 1-1/4" pocket hole screws
- 1-1/4" brad nails
- 1-1/4" screws
- Edge banding, optional
- Wood glue
- Sandpaper (100, 150, 220 grits)
- Finishing supplies (primer & paint, or stain, sealer)

Lumber:

- 5 – 1x2 at 8'
- 1 – 1x3 at 4'
- 2 – 1x3 at 8'
- 2 – 1x6 at 8'
- 1 – 4' x 8' sheet of 3/4" plywood

Cut List:

- 12 – 1x6 at 14" – Half Circles
- 2 – 1x3 at 39-1/2" – Inner Side Frames
- 4 – 1x3 at 13-1/2" – Outer Side Frames
- 4 – 1x3 at 44-1/2" – Outer Side Frames
- 8 – 1x2 at 16" – Shelf Frames
- 8 – 1x2 at 34-1/2" – Shelf Frames
- 3 – 3/4" plywood at 18-1/2" x 34-1/2" – Shelves
- 1 – 3/4" plywood at 19-1/2" x 37" – Top

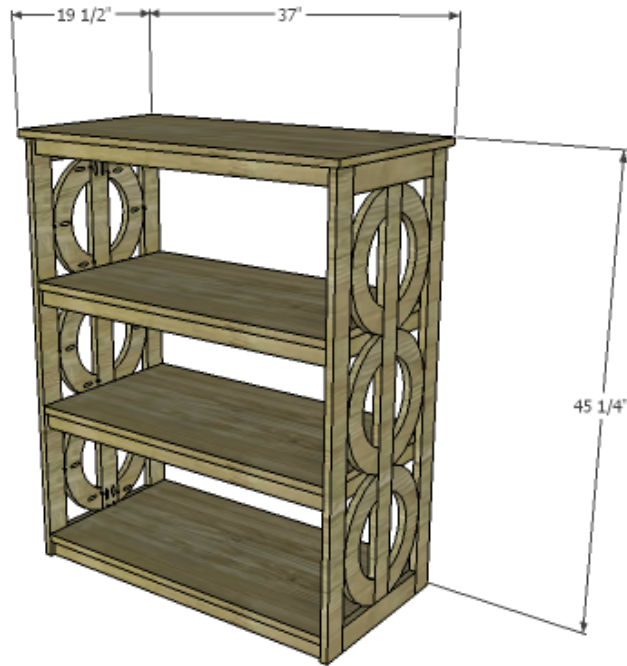

DESIGNS BY
STUDIO C

Click on the drawings for a larger view!

Step One

Edge banding will be applied to the exposed edges of the plywood prior to assembly.

Cut the pieces to length for the half circles. Print the [template](#) and tape the sheets together matching the registration marks. Cut the template with scissors and trace around the template on the 1x6 pieces. The pieces can be stacked and screwed (or hot glued) together so they can be cut apart in multiples. Use a jigsaw with a scrolling blade or a bandsaw with a 1/8" blade. Thoroughly sand the pieces. Set the pocket hole jig for 3/4" material and drill pocket holes as shown, the best way they will fit.

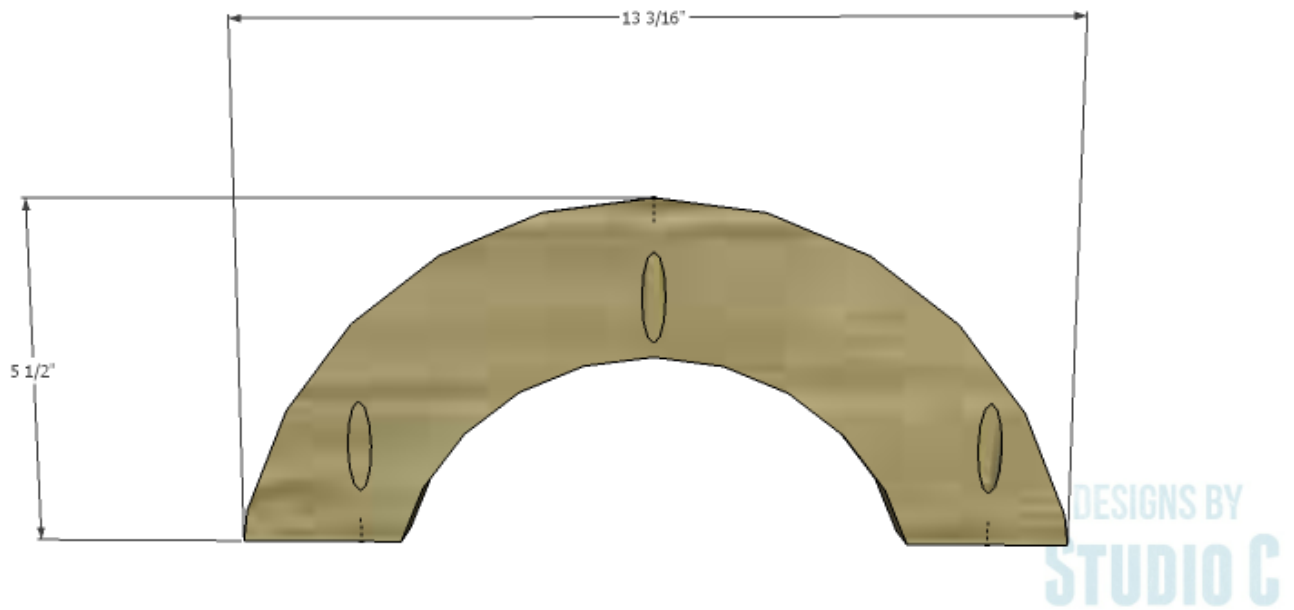

Step Two

Cut the 1x3 pieces for the inner side frame and drill pocket holes in each end. Secure the half-circle pieces to the 1x3 pieces using glue and 1-1/4" pocket hole screws.

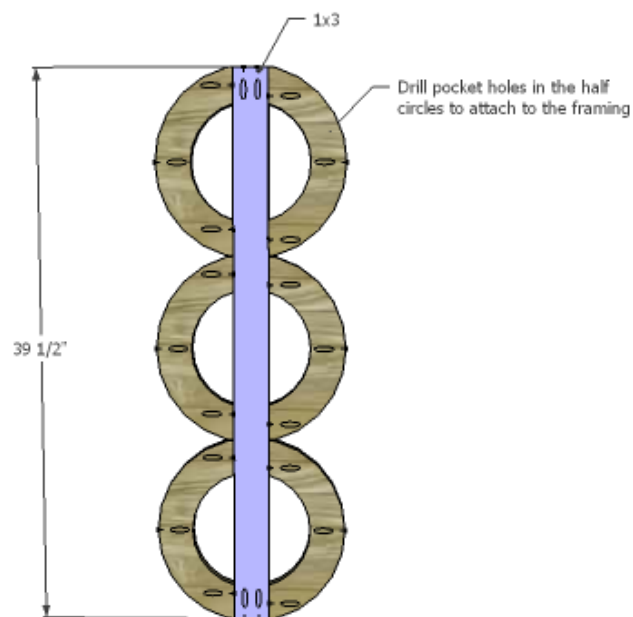

Step Three

Cut the pieces for the outer side frames and drill pocket holes in each end of the shorter pieces. Secure the pieces together to create the side panels using glue and 1-1/4" pocket hole screws.

It may be easier to fill all of the pocket holes before assembly.

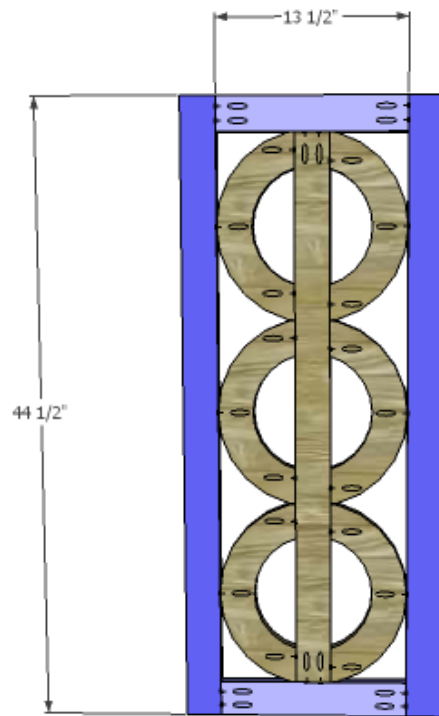

DESIGNS BY
STUDIO C

Step Four

Cut the pieces for the shelf frames. The frames can be assembled by drilling pocket holes in each end of the shorter pieces and securing with glue and 1-1/4" pocket hole screws, or by using glue and 1-1/4" brad nails.

Secure the shelf frames to the side panels using glue and countersunk 1-1/4" screws positioning the frames so they are 1/2" back from the side edges of the side panels.

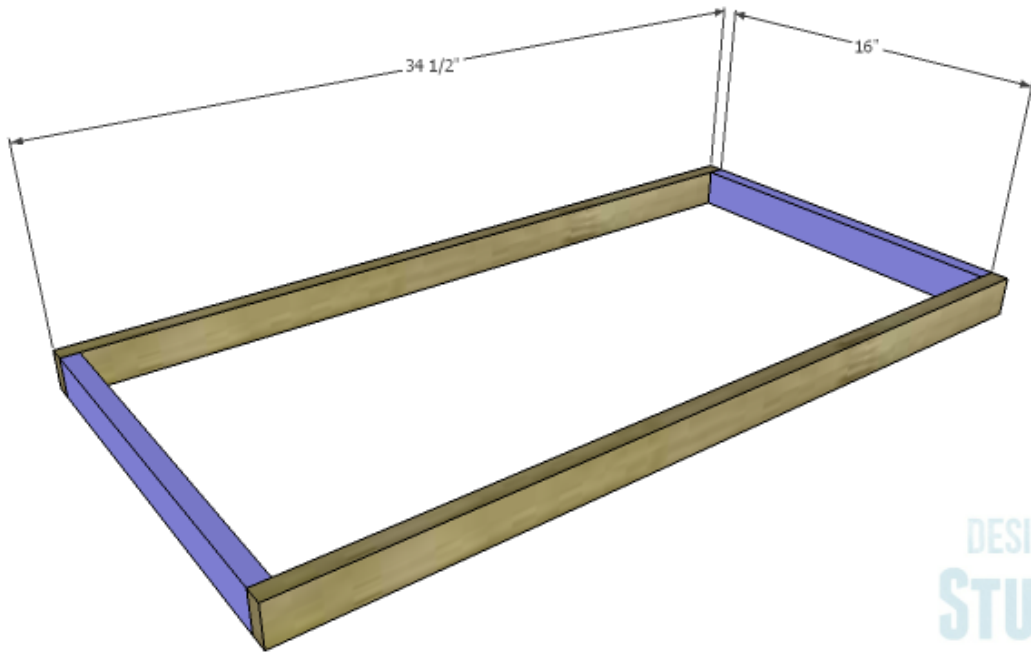

DESIGNS BY
STUDIO C

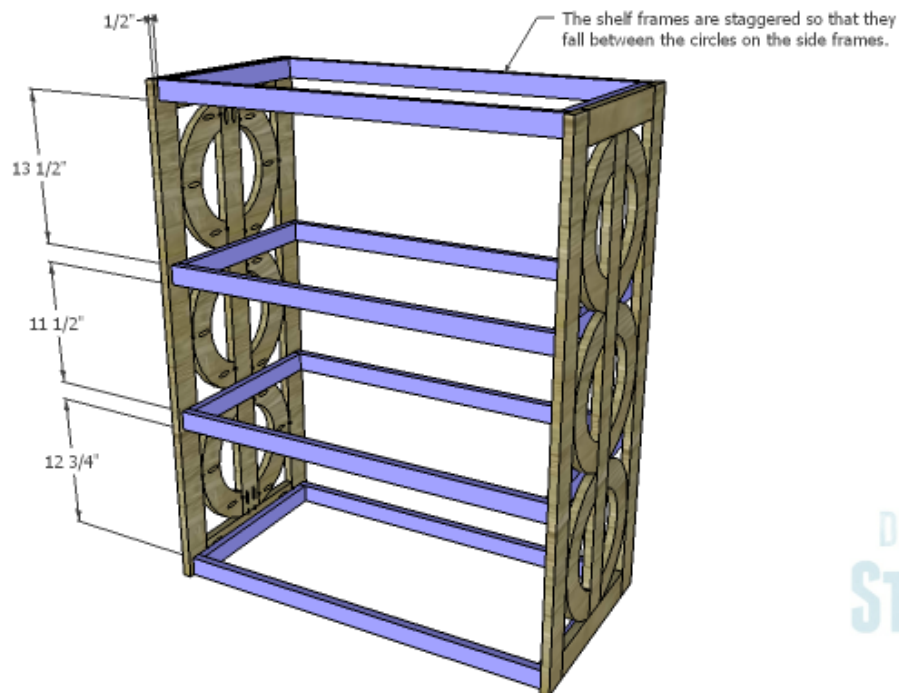

DESIGNS BY
STUDIO C

Step Five

Cut the pieces for the shelves. The front and back of the shelves will be flush with the side edges of the side panels and will overhang the frames by 1/2".

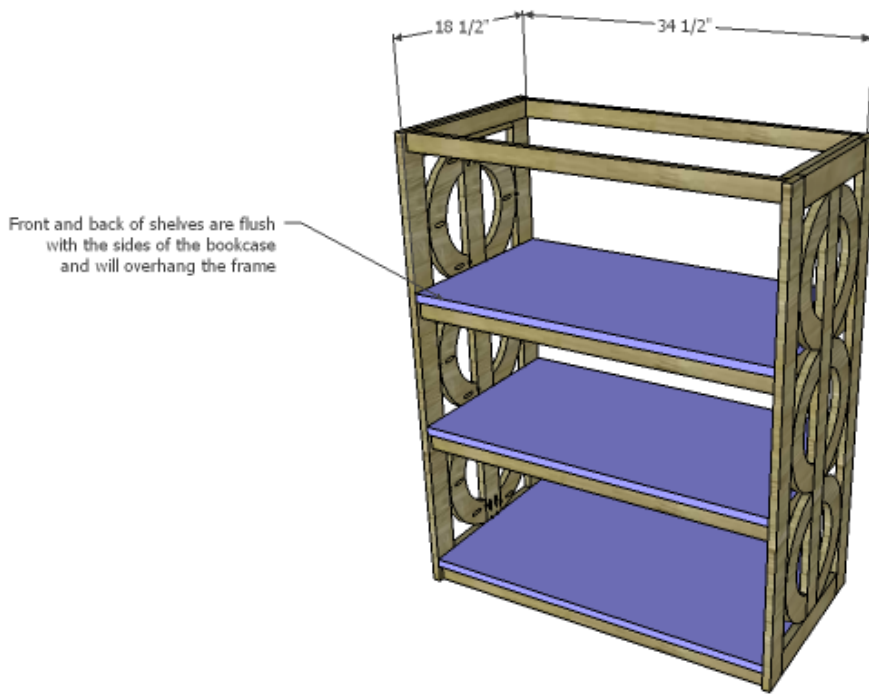

Step Six

Cut the piece for the top. The top will overhang by 1/2" on all sides. Secure in place using glue and 1-1/4" brad nails.

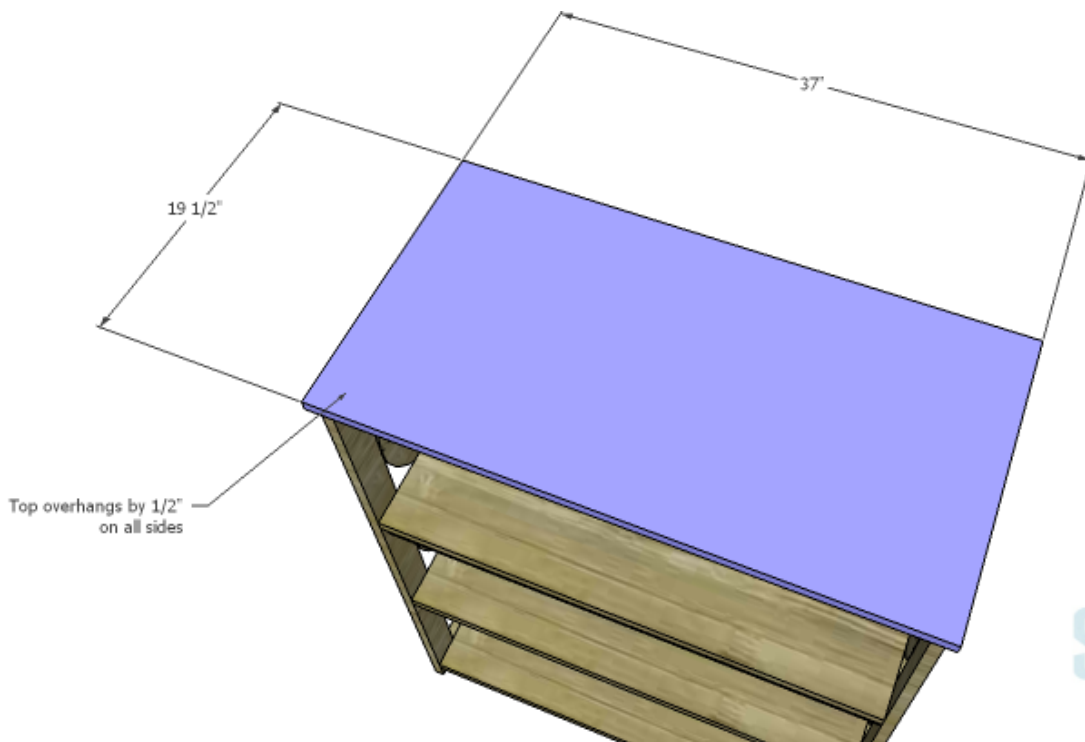

Finish as desired.

This bookcase would make an excellent addition to any room. It

can also be used in a bathroom to store toiletries and clean towels! Have any questions about the DIY plans to build a Circle Bookcase? Leave a comment below!